

Activity Tables

4000 and 5000 Series Solutions



Furniture That Fits®

Redefining Activity Tables

The “activity” in activity tables used to be defined by building blocks and colorful crayons . . . but that was then. Today, with its simple design and expanded color palette, Virco’s collection of classic and contemporary table styles provides a whole new look for a wide range of environments.

Sturdy, versatile, and supremely capable, Virco Series 4000 and 5000 tables are the new definition of activity table for today’s dynamic classrooms, dining areas, commons and conference centers.



Tables That Support Your Activity

Add a book box to transform a basic table into a student desk or link them together to form larger, sturdy work surfaces. Facilitate small group interaction with complementary designs that nest together - then regroup into new patterns that reinforce the concept of creative thinking. No matter what the activity or environment, there is a Virco Activity Table that’s perfect for you.

Tables - With A Twist

The tabletop is where it all begins. With distinct shapes and a multitude of sizes, Virco tables form a solid foundation for classroom, café, workroom or seminar activities. Choose from an array of tables that can be organized in a group, split into separate areas, set at different heights or a combination of all three.

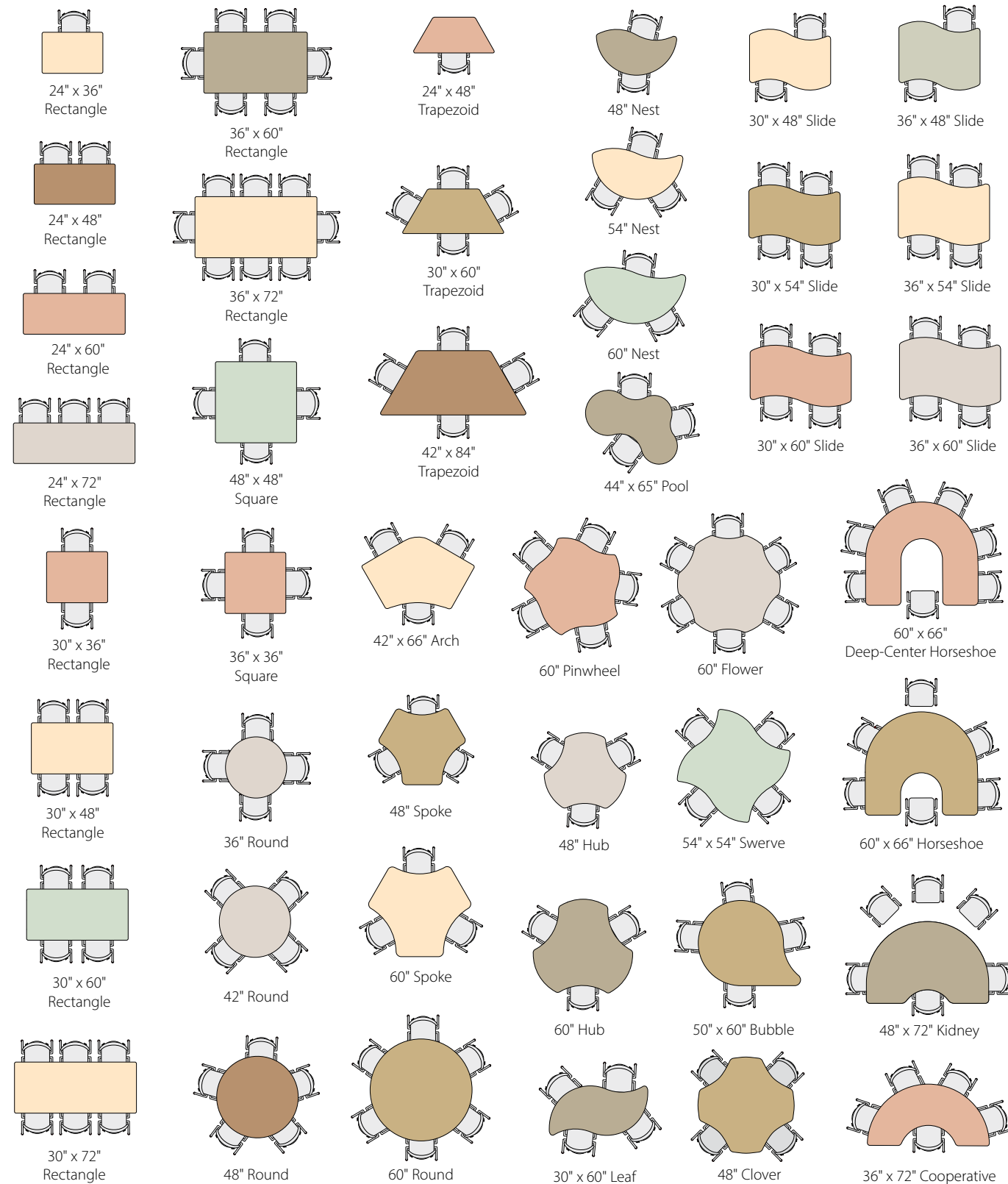

NOTE: Seating shown with 4000 Series tables. Configurations may vary depending on chair/occupant size.

Legs That Stand Out ... & Stand Up

Coordinate Virco Activity Tables with your room aesthetics by selecting thin or thick profile legs. Choose 4000 Series tables for the classic look of a thin profile or make a bold statement with the 5000 Series featuring a thick profile. There are also a number of models available with stand-up height legs (see chart on page 16). Each series can be configured with fixed or adjustable legs in various heights to accommodate the ideal set-up for every size.



4000 Series Thin Profile Legs				5000 Series Thick Profile Legs							
LO 17" - 25" Adj-Height Nylon Glides	STANDARD 22" - 30" Adj-Height Nylon Glides	N (FIXED) 30" Fixed-Height Nylon Glides	W (WHEELCHAIR) 26" - 34" Adj-Height Nylon Glides	ADJCLO 21" - 29" Adj-Height Lock Casters	ADJLO 19" - 27" Adj-Height ABS Glides	ADJC 26" - 34" Adj-Height Lock Casters	ADJ 24" - 32" Adj-Height ABS Glides	30C (FIXED) 30" Fixed-Height Lock Casters	30 (FIXED) 30" Fixed-Height ABS Glides	ADJCSU 30" - 39" Adj-Height Lock Casters	ADJSU 30" - 39" Adj-Height Nylon Glides
48FLRLEG - 14 1/4" - 22 1/4" Adj-Height Nylon Glides The 4000 Series Adjustable Floor Table Conversion Kit includes a set of 4 lower legs only and enables a top height of 14 1/4" - 22 1/4". These legs are intended as a lower leg substitution for Virco 4000 Series adjustable-height activity tables only.				5000 Series Models listed below have a thick gusset leg.							
				20" - 29" Adj-Height 503672ADJ 5060RADJ 50HORS60ADJ 50KID72ADJ 503672ADJC 5060RADJC 50HORS60ADJC 50KID72ADJC 50HORS60DCADJ 50HORS60DCADIC 50AR4266ADJ 50AR4266ADJC		30" Fixed-Height 50367230 5060R30 50HORS6030 50KID7230 50HORS60DC30 50AR426630					

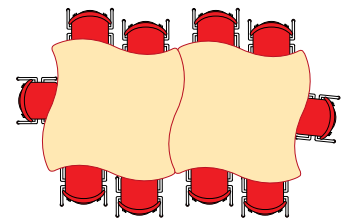

2 Swerve Tables

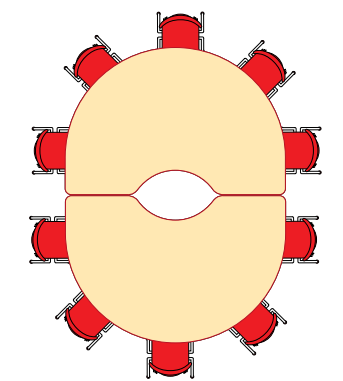

2 Kidney Tables

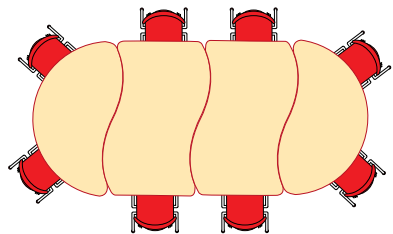

2 Nest Tables, 2 Slide Tables

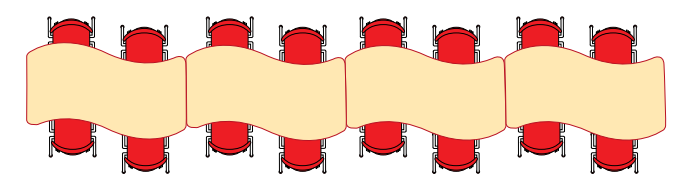

4 Slide Tables

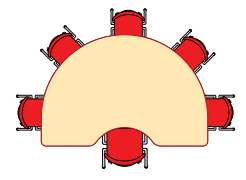

Installation: 4000 Series Kidney tables with Analogy® seating.



4000 Series Kidney table



5000 Series Kidney table

Foundation For Learning

Easily configured and able to accommodate scholars of every age, Virco Activity Tables are ideal for the dynamic atmosphere of the 21st century classroom. Our Activity Tables support every stage and style of learning - from independent study to collaborative group work and creative hands-on projects. With nesting shapes that can be grouped in pods then split apart for different uses, and a selection of height-adjustable legs that can handle the smallest preschooler to the tallest graduate, Virco Activity Tables are the perfect choice for versatile educational environments.

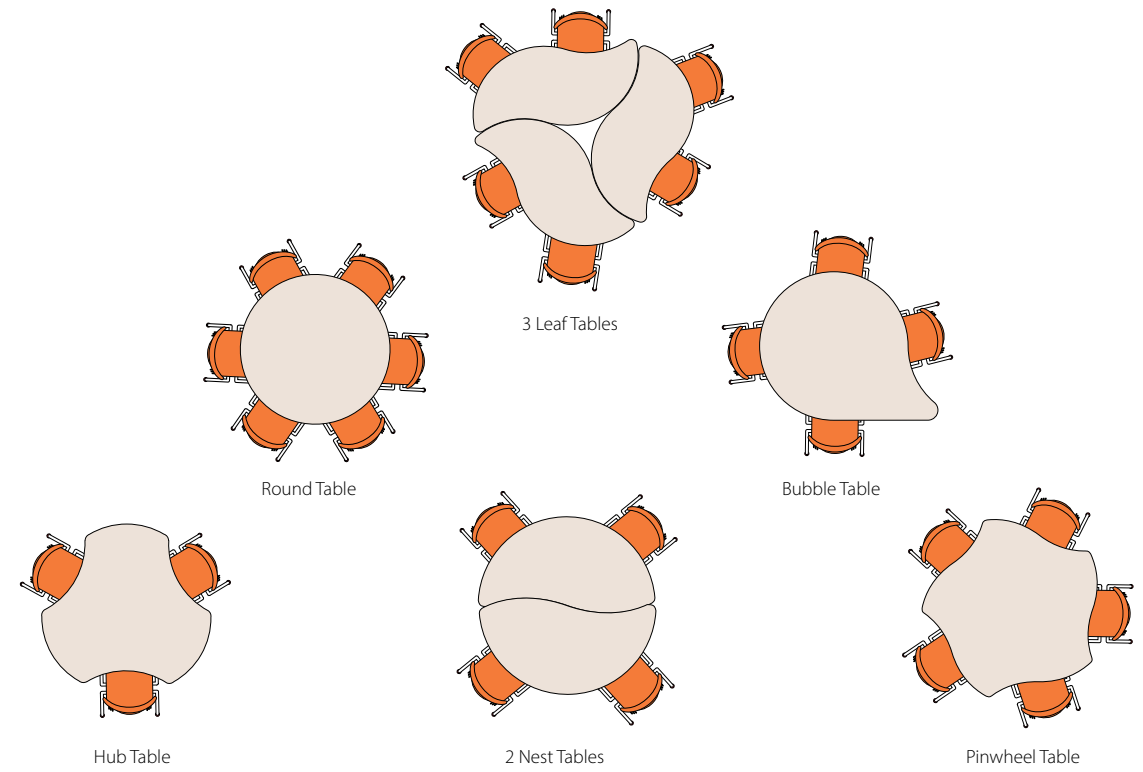

Café Culture

Got a curvy wall? Try a curvy table. Expand upon your interior architecture with Virco Activity Tables that conform to your space. Nesting shapes and easy portability allow you to redesign on the fly or adapt the space for special events. Choose from a virtually endless combination of colors, leg styles and shapes that range from the traditional to whimsical.

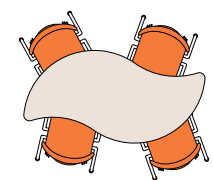

Installation: 4000 Series Leaf tables with Virtuoso® seating.



4000 Series Leaf table



5000 Series Leaf table

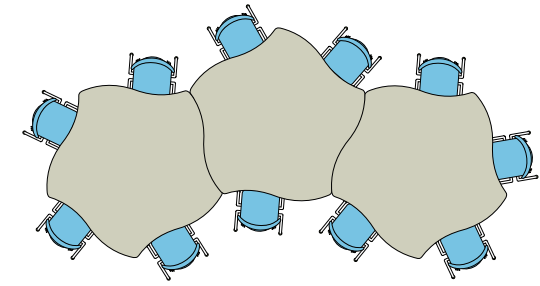

3 Pinwheel Tables

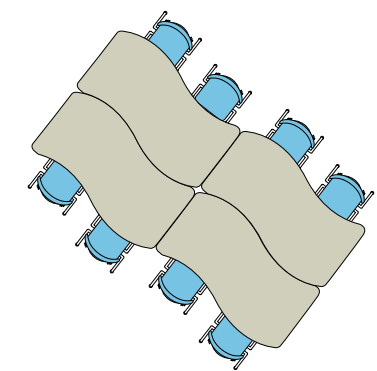

4 Slide Tables

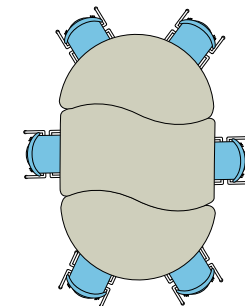

2 Nest Tables, 1 Slide Table

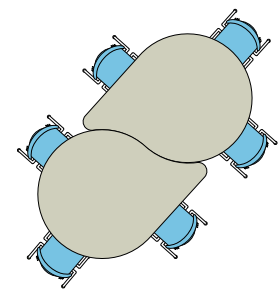

2 Bubble Tables

UNcommons

Lighten and brighten up common areas with innovative tables that support multiple modes of learning, working and socializing within a single environment. User friendly shapes, diverse leg profiles and accessories make customizing different zones a simple, intuitive experience.

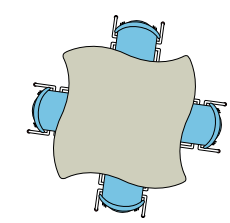

Installation: 5000 Series Swerve table with ZUMA® seating.



4000 Series Swerve table



5000 Series Swerve table

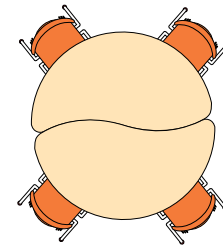

2 Nest Tables

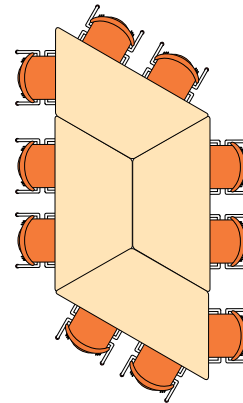

4 Trapezoid Tables

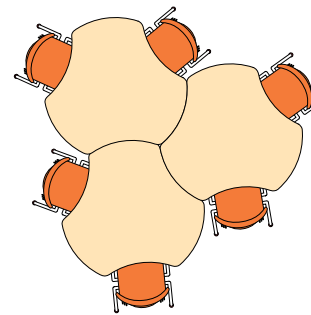

3 Hub Tables

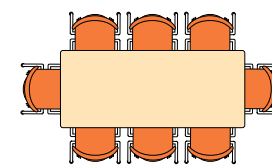

Installation: 4000 Series Rectangle table with Sage™ seating.

Creative Conference Calls

The modern office doesn't need to be confined to cubicles with stationary desks and fixed seating arrangements. Redefine your work space with tables that are appropriate for the task and offer the versatility to transform any space in an instant. Mix a variety of shapes to form patterns that can be used in the conference room then broken apart for individual projects. Virco Activity Tables have the aesthetics to serve throughout the workplace and the functionality to get the job done every time.



4000 Series Rectangle table



5000 Series Rectangle table

4000 & 5000 SERIES – Does Not Include Stand-Up Models
Book boxes and tote trays cannot be used simultaneously.

5000 SERIES – Stand-Up & Stand-Up Caster Models Only
Book boxes and tote trays cannot be used simultaneously.

Table Shape	BASE MODEL NO.	UBOOK MAX. NO.	UTOTE MAX. NO.
	2436	1	0
	2448	2	1
	2460	2	2
	2472	3	2
	3036	2	0
	3048	4	2
	3060	4	2
	3072	6	4
	3636	2	0
	3660	4	4
	3672	6	4
	4848	4	4
	36R	0	0
	42R	0	0
	48R	4	2
	60R	4	4
	COOP72	0	0
	KID72	3	1
	HORSE60	3	3
	HORSE60DC	2	2
	TRAP48	1	1
	TRAP60	1	1
	TRAP84	3	3
	AR4266*	3	3
	SL3048	0	0
	SL3054	2	2
	SL3060	2	2
	SL3648	2	2
	SL3654	2	2
	SL3660	2	2
	POOL	0	0
	CLO48	2	2
	FLOW60	4	4
	HUB48	0	0
	HUB60	3	3
	SPK48	0	0
	SPK60	3	3
	SWV54	4	4
	PIN60	2	2
	BU5060	3	3
	LF3060	0	0
	NEST48	0	0
	NEST54	0	0
	NEST60	0	0

*5000 Series only.

Table Shape	BASE MODEL NO.	UBOOK MAX. NO.	UTOTE MAX. NO.
	2436	0	0
	2448	1	1
	2460	2	2
	2472	3	2
	3036	0	0
	3048	2	2
	3060	2	2
	3072	3	4
	3636	0	0
	3660	4	4
	3672	6	4
	4848	4	4
	36R	0	0
	42R	0	0
	48R	0	0
	60R	4	4
	COOP72	0	0
	KID72	1	1
	HORSE60	3	3
	HORSE60DC	2	2
	TRAP48	1	1
	TRAP60	1	1
	TRAP84	1	1
	AR4266	3	3
	SL3048	0	0
	SL3054	0	2
	SL3060	2	2
	SL3648	2	2
	SL3654	2	2
	SL3660	2	2
	POOL	0	0
	CLO48	0	0
	FLOW60	4	4
	HUB48	0	0
	HUB60	3	3
	SPK48	0	0
	SPK60	3	3
	SWV54	4	4
	PIN60	0	0
	BU5060	2	2
	LF3060	0	0
	NEST48	0	0
	NEST54	0	0
	NEST60	0	0

Options & Accessories

Virco's offers a wide range of leg styles and options for a variety of table shapes designed to support the differing needs of a campus.

To further enhance the functionality, add optional book boxes or tote trays to your Activity Tables for books, supplies and additional storage. See chart on next page for book box and tote tray compatibility.



Tote Tray - UTOTE

Plastic tote tray measuring 16"W x 12"D x 4"H. Overall dimensions with tote-tray runners: 18 1/4"W x 13 1/2"D x 4"H.



Book Box - UBOOK

Plastic open-front book box measuring 15 1/2"W x 14"D x 4 1/2"H.



LEG STYLES

4000 Series Thin Profile Legs

Table models highlighted in GREEN come with these legs.

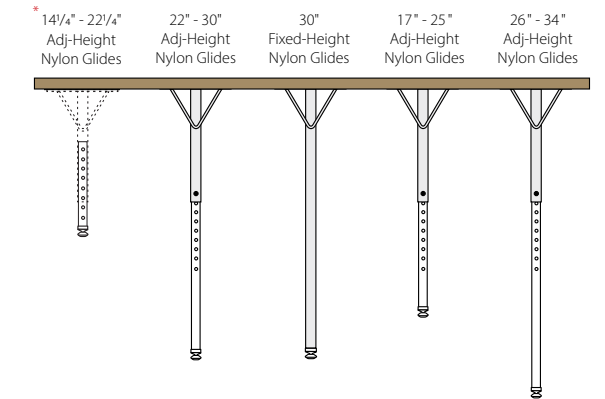

* Also Available: **48FLRLEG** - 4000 Series Adjustable Floor Table Conversion Kit includes a set of 4 lower legs only and enables a top height of 14 1/4" - 22 1/4". Intended for use with Virco 4000 Series adjustable-height activity tables only.

5000 Series Thick Profile Legs

Table models highlighted in BLUE come with these legs.

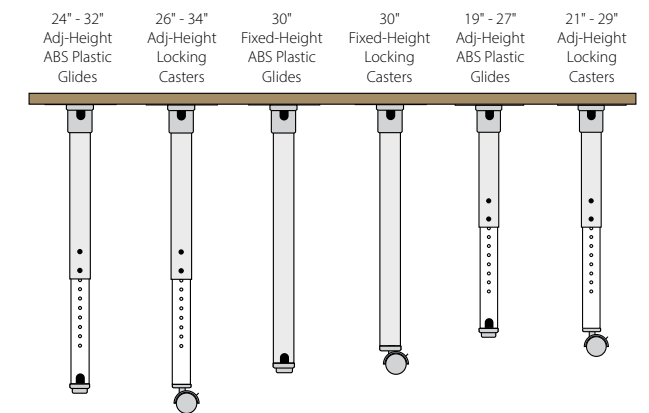

5000 Series Gusset Legs

Table models highlighted in THESE COLORS come with these legs.

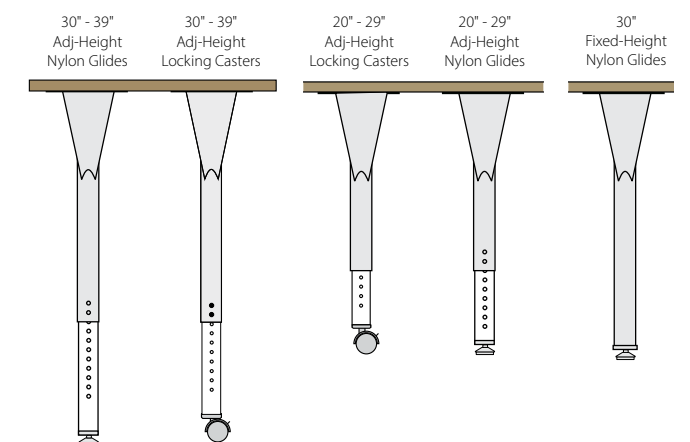
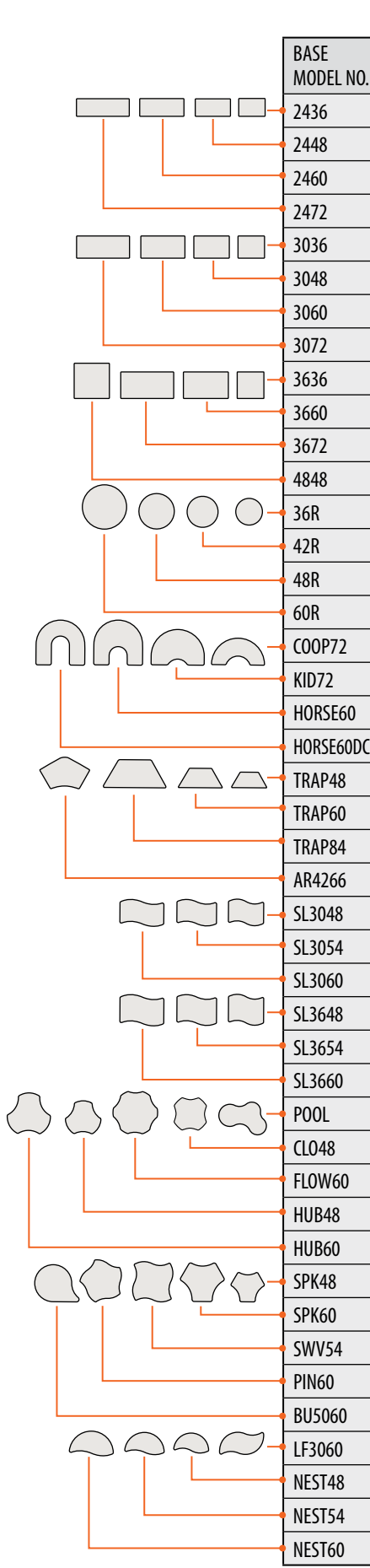

TABLE SHAPES

4000 SERIES MODELS

5000 SERIES MODELS



BASE MODEL NO.	ADJUSTABLE 22"-30"	CHRM ADJ/CHROME 22"-30"	N FIXED/CHROME 30"	LO ADJUSTABLE 17"-25"	LOCHRM ADJUSTABLE/CHROME 17"-25"	W ADJ/WHEELCHAIR 26"-34"
2436	482436	482436CHRM	482436N	482436LO	482436LOCHRM	482436W
2448	482448	482448CHRM	482448N	482448LO	482448LOCHRM	482448W
2460	482460	482460CHRM	482460N	482460LO	482460LOCHRM	482460W
2472	482472	482472CHRM	482472N	482472LO	482472LOCHRM	482472W
3036	483036	483036CHRM	483036N	483036LO	483036LOCHRM	483036W
3048	483048	483048CHRM	483048N	483048LO	483048LOCHRM	483048W
3060	483060	483060CHRM	483060N	483060LO	483060LOCHRM	483060W
3072	483072	483072CHRM	483072N	483072LO	483072LOCHRM	483072W
3636	483636	483636CHRM	483636N	483636LO	483636LOCHRM	483636W
3660	483660	483660CHRM	483660N	483660LO	483660LOCHRM	483660W
3672	483672	483672CHRM	483672N	483672LO	483672LOCHRM	483672W
4848	484848	484848CHRM	484848N	484848LO	484848LOCHRM	484848W
36R	4836R	4836RCHRM	4836RN	4836RLO	4836RLOCHRM	4836RW
42R	4842R	4842RCHRM	4842RN	4842RLO	4842RLOCHRM	4842RW
48R	4848R	4848RCHRM	4848RN	4848RLO	4848RLOCHRM	4848RW
60R	4860R	4860RCHRM	4860RN	4860RLO	4860RLOCHRM	4860RW
COOP72	48COOP72	48COOP72CHRM	48COOP72N	48COOP72LO	48COOP72LOCHRM	48COOP72W
KID72	48KID72	48KID72CHRM	48KID72N	48KID72LO	48KID72LOCHRM	48KID72W
HORSE60	48HORSE60	48HORSE60CHRM	48HORSE60N	48HORSE60LO	48HORSE60LOCHRM	48HORSE60W
HORSE60DC	48HORSE60DC	48HORSE60DCCHRM	48HORSE60DCN	48HORSE60DCLO	48HORSE60DCLOCHRM	48HORSE60DCW
TRAP48	48TRAP48	48TRAP48CHRM	48TRAP48N	48TRAP48LO	48TRAP48LOCHRM	48TRAP48W
TRAP60	48TRAP60	48TRAP60CHRM	48TRAP60N	48TRAP60LO	48TRAP60LOCHRM	48TRAP60W
TRAP84	48TRAP84	48TRAP84CHRM	48TRAP84N	48TRAP84LO	48TRAP84LOCHRM	48TRAP84W
AR4266						
SL3048	48SL3048	48SL3048CHRM	48SL3048N	48SL3048LO	48SL3048LOCHRM	48SL3048W
SL3054	48SL3054	48SL3054CHRM	48SL3054N	48SL3054LO	48SL3054LOCHRM	48SL3054W
SL3060	48SL3060	48SL3060CHRM	48SL3060N	48SL3060LO	48SL3060LOCHRM	48SL3060W
SL3648	48SL3648	48SL3648CHRM	48SL3648N	48SL3648LO	48SL3648LOCHRM	48SL3648W
SL3654	48SL3654	48SL3654CHRM	48SL3654N	48SL3654LO	48SL3654LOCHRM	48SL3654W
SL3660	48SL3660	48SL3660CHRM	48SL3660N	48SL3660LO	48SL3660LOCHRM	48SL3660W
POOL	48POOL	48POOLCHRM	48POOLN	48POOLLO	48POOLLOCHRM	48POOLW
CLO48	48CLO48	48CLO48CHRM	48CLO48N	48CLO48LO	48CLO48LOCHRM	48CLO48W
FLOW60	48FLOW60	48FLOW60CHRM	48FLOW60N	48FLOW60LO	48FLOW60LOCHRM	48FLOW60W
HUB48	48HUB48	48HUB48CHRM	48HUB48N	48HUB48LO	48HUB48LOCHRM	48HUB48W
HUB60	48HUB60	48HUB60CHRM	48HUB60N	48HUB60LO	48HUB60LOCHRM	48HUB60W
SPK48	48SPK48	48SPK48CHRM	48SPK48N	48SPK48LO	48SPK48LOCHRM	48SPK48W
SPK60	48SPK60	48SPK60CHRM	48SPK60N	48SPK60LO	48SPK60LOCHRM	48SPK60W
SWV54	48SWV54	48SWV54CHRM	48SWV54N	48SWV54LO	48SWV54LOCHRM	48SWV54W
PIN60	48PIN60	48PIN60CHRM	48PIN60N	48PIN60LO	48PIN60LOCHRM	48PIN60W
BU5060	48BU5060	48BU5060CHRM	48BU5060N	48BU5060LO	48BU5060LOCHRM	48BU5060W
LF3060	48LF3060	48LF3060CHRM	48LF3060N	48LF3060LO	48LF3060LOCHRM	48LF3060W
NEST48	48NEST48	48NEST48CHRM	48NEST48N	48NEST48LO	48NEST48LOCHRM	48NEST48W
NEST54	48NEST54	48NEST54CHRM	48NEST54N	48NEST54LO	48NEST54LOCHRM	48NEST54W
NEST60	48NEST60	48NEST60CHRM	48NEST60N	48NEST60LO	48NEST60LOCHRM	48NEST60W

ADJ ADJUSTABLE 24"-32"	ADJC ADJ/CASTER 26"-34"	30 FIXED-HEIGHT 30"	30C FIXED-HT/CASTER 30"	ADJLO ADJUSTABLE 19"-27"	ADJCLO ADJ/CASTER 21"-29"	ADJSU ADJ/STAND-UP 30"-39"	ADJCSU ADJ/STAND-UP/CASTERS 30"-39"
502436ADJ	502436ADJC	50243630	50243630C	502436ADJLO	502436ADJCLO	502436ADJSU	502436ADJCSU
502448ADJ	502448ADJC	50244830	50244830C	502448ADJLO	502448ADJCLO	502448ADJSU	502448ADJCSU
502460ADJ	502460ADJC	50246030	50246030C	502460ADJLO	502460ADJCLO	502460ADJSU	502460ADJCSU
502472ADJ	502472ADJC	50247230	50247230C	502472ADJLO	502472ADJCLO	502472ADJSU	502472ADJCSU
503036ADJ	503036ADJC	50303630	50303630C	503036ADJLO	503036ADJCLO	503036ADJSU	503036ADJCSU
503048ADJ	503048ADJC	50304830	50304830C	503048ADJLO	503048ADJCLO	503048ADJSU	503048ADJCSU
503060ADJ	503060ADJC	50306030	50306030C	503060ADJLO	503060ADJCLO	503060ADJSU	503060ADJCSU
503072ADJ	503072ADJC	50307230	50307230C	503072ADJLO	503072ADJCLO	503072ADJSU	503072ADJCSU
503636ADJ	503636ADJC	50363630	50363630C	503636ADJLO	503636ADJCLO	503636ADJSU	503636ADJCSU
503660ADJ	503660ADJC	50366030	50366030C	503660ADJLO	503660ADJCLO	503660ADJSU	503660ADJCSU
503672ADJ	503672ADJC	50367230				503672ADJSU	503672ADJCSU
504848ADJ	504848ADJC	50484830	50484830C	504848ADJLO	504848ADJCLO	504848ADJSU	504848ADJCSU
5036RADJ	5036RADJC	5036R30	5036R30C	5036RADJLO	5036RADJCLO	5036RADJSU**	5036RADJCSU**
5042RADJ	5042RADJC	5042R30	5042R30C	5042RADJLO	5042RADJCLO	5042RADJSU	5042RADJCSU
5048RADJ	5048RADJC	5048R30	5048R30C	5048RADJLO	5048RADJCLO	5048RADJSU	5048RADJCSU
5060RADJ	5060RADJC	5060R30				5060RADJSU	5060RADJCSU
50COOP72ADJ	50COOP72ADJC	50COOP7230	50COOP7230C	50COOP72ADJLO	50COOP72ADJCLO	50COOP72ADJSU	50COOP72ADJCSU
50KID72ADJ	50KID72ADJC	50KID7230				50KID72ADJSU	50KID72ADJCSU
50HORS60ADJ	50HORS60ADJC	50HORS6030				50HORS60ADJSU	50HORS60ADJCSU
50HORS60DCADJ	50HORS60DCADJC	50HORS60DC30				50HORS60DCADJSU	50HORS60DCADJCSU
50TRAP48ADJ	50TRAP48ADJC	50TRAP4830	50TRAP4830C	50TRAP48ADJLO	50TRAP48ADJCLO	50TRAP48ADJSU	50TRAP48ADJCSU
50TRAP60ADJ	50TRAP60ADJC	50TRAP6030	50TRAP6030C	50TRAP60ADJLO	50TRAP60ADJCLO	50TRAP60ADJSU	50TRAP60ADJCSU
50TRAP84ADJ	50TRAP84ADJC	50TRAP8430	50TRAP8430C	50TRAP84ADJLO	50TRAP84ADJCLO	50TRAP84ADJSU	50TRAP84ADJCSU
50AR4266ADJ	50AR4266ADJC	50AR426630				50AR4266ADJSU	50AR4266ADJCSU
50SL3048ADJ	50SL3048ADJC	50SL304830	50SL304830C	50SL3048ADJLO	50SL3048ADJCLO	50SL3048ADJSU	50SL3048ADJCSU
50SL3054ADJ	50SL3054ADJC	50SL305430	50SL305430C	50SL3054ADJLO	50SL3054ADJCLO	50SL3054ADJSU	50SL3054ADJCSU
50SL3060ADJ	50SL3060ADJC	50SL306030	50SL306030C	50SL3060ADJLO	50SL3060ADJCLO	50SL3060ADJSU	50SL3060ADJCSU
50SL3648ADJ	50SL3648ADJC	50SL364830	50SL364830C	50SL3648ADJLO	50SL3648ADJCLO	50SL3648ADJSU	50SL3648ADJCSU
50SL3654ADJ	50SL3654ADJC	50SL365430	50SL365430C	50SL3654ADJLO	50SL3654ADJCLO	50SL3654ADJSU	50SL3654ADJCSU
50SL3660ADJ	50SL3660ADJC	50SL366030	50SL366030C	50SL3660ADJLO	50SL3660ADJCLO	50SL3660ADJSU	50SL3660ADJCSU
50POOLADJ	50POOLADJC	50POOL30	50POOL30C	50POOLADJLO	50POOLADJCLO		
50CLO48ADJ	50CLO48ADJC	50CLO4830	50CLO4830C	50CLO48ADJLO	50CLO48ADJCLO	50CLO48ADJSU	50CLO48ADJCSU
50FLOW60ADJ	50FLOW60ADJC	50FLOW6030	50FLOW6030C	50FLOW60ADJLO	50FLOW60ADJCLO	50FLOW60ADJSU	50FLOW60ADJCSU
50HUB48ADJ	50HUB48ADJC	50HUB4830	50HUB4830C	50HUB48ADJLO	50HUB48ADJCLO	50HUB48ADJSU	50HUB48ADJCSU
50HUB60ADJ	50HUB60ADJC	50HUB6030	50HUB6030C	50HUB60ADJLO	50HUB60ADJCLO	50HUB60ADJSU	50HUB60ADJCSU
50SPK48ADJ	50SPK48ADJC	50SPK4830	50SPK4830C	50SPK48ADJLO	50SPK48ADJCLO	50SPK48ADJSU	50SPK48ADJCSU
50SPK60ADJ	50SPK60ADJC	50SPK6030	50SPK6030C	50SPK60ADJLO	50SPK60ADJCLO	50SPK60ADJSU	50SPK60ADJCSU
50SWV54ADJ	50SWV54ADJC	50SWV5430	50SWV5430C	50SWV54ADJLO	50SWV54ADJCLO	50SWV54ADJSU	50SWV54ADJCSU
50PIN60ADJ	50PIN60ADJC	50PIN6030	50PIN6030C	50PIN60ADJLO	50PIN60ADJCLO	50PIN60ADJSU	50PIN60ADJCSU
50BU5060ADJ	50BU5060ADJC	50BU506030	50BU506030C	50BU5060ADJLO	50BU5060ADJCLO	50BU5060ADJSU	50BU5060ADJCSU
50LF3060ADJ	50LF3060ADJC	50LF306030	50LF306030C	50LF3060ADJLO	50LF3060ADJCLO	50LF3060ADJSU	50LF3060ADJCSU
50NEST48ADJ		50NEST4830		50NEST48ADJLO		50NEST48ADJSU	
50NEST54ADJ		50NEST5430		50NEST54ADJLO		50NEST54ADJSU	
50NEST60ADJ		50NEST6030		50NEST60ADJLO		50NEST60ADJSU	

20"-29" adjustable-height gusset leg 30" fixed-height gusset leg Configuration not available. **17 1/2" chair clearance between legs



Safe Environments

Virco proudly complies with all laws and governmental regulations affecting our products, including the California Air Resources Board (CARB) regulation on formaldehyde emissions from composite wood products and the federal Consumer Product Safety Improvement Act of 2008 (CPSIA). For information on GREENGUARD indoor air quality certification, ANSI/ BIFMA and product warranty information, visit virco.com.

Proudly Designed, Manufactured And Assembled By American Workers

Since 1950, when we opened our doors in Southern California, Virco has been proud to design, manufacture and assemble our products in the U.S.



Virco Inc. • 2027 Harpers Way • Torrance, CA 90501 • 1-800-44-VIRCO • virco.com

Copyright 2023, Virco, all rights reserved. Virco®, Analogy®, ZUMA® and PlanSCAPE® and Virtuoso® are registered at the U.S. Patent and Trademark Office. Sage™ is a trademark of Virco Mfg. Corporation.

PRINTED IN THE U.S.A. 9/23

REF# 24008